



MITUS
210MA

APPLICATIONS

- Live sound reinforcement floor monitor
- Touring systems, Clubs, Auditoriums, Theatres
- Houses of worship, D.J. booth monitor

FEATURES

- 2-way bi-amplified bass reflex design with coaxial driver
- 1 x 10" B&C custom neodymium magnet coaxial speaker with 2.5" voice coil
- 1.4" exit titanium compression driver with 2.5" voice coil
- B&C custom 10" neodymium magnet woofer with 2.5" voice coil
- 600W RMS LF & 300W RMS HF class D built-in amplifiers
- 70° conical dispersion
- Input panel with XLR in/link, volume, preset, HP filter, GND lift
- SPL capability 134dB
- 0.59" birch plywood enclosure
- 1.38" stand socket
- Completely Manufactured in Italy

PROCESSED ACTIVE STAGE MONITOR



МУЗЦЕНТР
МУЗЫКАЛЬНОЕ ОБОРУДОВАНИЕ

<https://muzcentre.ru>

PRODUCT DESCRIPTION

The FBT MITUS 210MA bi-amplified speaker feature 0.59" birch plywood construction; the front shall be protected by a heavy duty metal grille with anti-resonance spacers and exclusive synthetic cloth to protect the drivers and a rugged touring grade scratch resistant black paint finish protects the cabinet exterior. The FBT MITUS 210MA is a two way coaxial design incorporating a 10" B&C custom neodymium magnet coaxial speaker with 2.5" voice coil and 1.4" exit titanium compression driver with 2.5" voice coil, a 10" neodymium magnet woofer with 2.5" voice coil, a class D built-in amplifiers 600W RMS to the LF and 300W RMS to the HF with switch mode power supply. The FBT MITUS 210MA provides a DSP with A/D-D/A low noise converters with 8 selectable presets. The FBT MITUS 210MA shall meet the following performance criteria: Frequency response of 60Hz to 20kHz, Maximum SPL of 132dB, Nominal impedance 8 Ohm LF / 8 Ohm HF. The control panel provides XLR «in&link», volume, preset, HP filter, GND lift switch. A standard 1.38" speaker stand socket allows the FBT MITUS 210MA to be mounted on speaker stand.

ELECTRICAL PERFORMANCE

System Type	2-way
Built-in Amplifiers LF / HF *	cont.: 400W RMS / 200W RMS max.: 600W RMS / 300W RMS peak.: 1200W / 600W
Frequency Response @ -6dB	60Hz - 20kHz
Input Impedance	22kOhm
Maximum SPL (cont. / peak) **	127dB / 134dB
Dispersion	70° conical
Crossover Frequency	1.2 kHz
AC Power requirement	640 VA

PHYSICAL

Low Frequency Woofer	2 x 10" - 2.5" coil
High Frequency Driver	1 x 1.4" - 2.5" coil
Input Connectors	XLR with loop
Net Dimensions (WxHxD)	22.6" x 11.4" x 15.8" 574 x 290 x 402mm
Shipping Dimensions (WxHxD)	26.57" x 15.55" x 20.07" 675 x 395 x 510mm
Net Weight	41.9 lbs / 19 kg
Shipping Weight	46.5 lbs / 21.1 kg
Enclosure Material	birch plywood
Power cord	5 mt.

* CONT.: 500mS, rms power on nominal speaker impedance
MAX.: 2mS burst, rms power on nominal speaker impedance
MAX PEAK: based on max peak output voltage and nominal speaker impedance

** CONT. SPL: free space, based on continuous power amp rating and LF transducer average sensitivity data, 125mS time average
PEAK SPL: free space, based on max peak power amp rating and system peak sensitivity, 10mS time average

DIAGRAMS

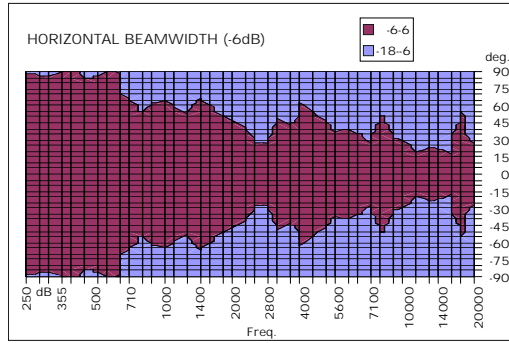

HORIZONTAL POLAR DIAGRAM

— 250 — 500 — 1000 — 2000 — 4000 — 8000 — 12500 — 16000

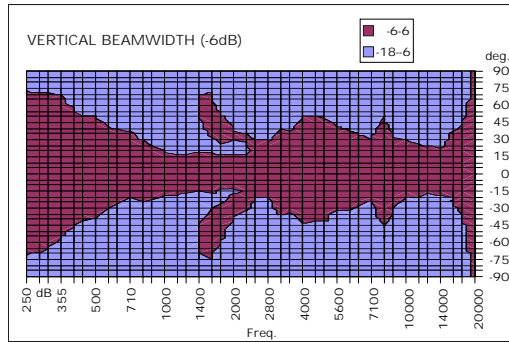
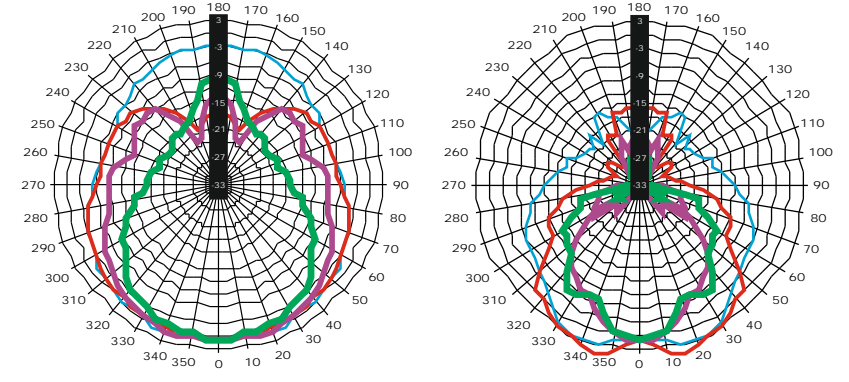

VERTICAL POLAR DIAGRAM

— 250 — 500 — 800 — 1000 — 1400 — 2000 — 2500 — 3150

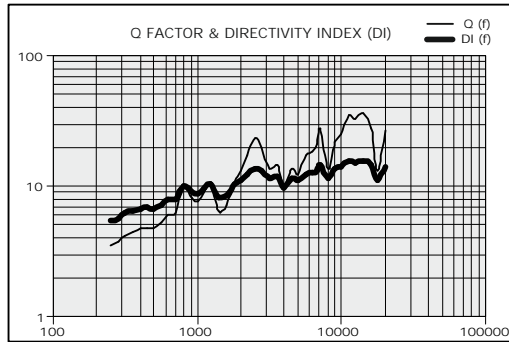
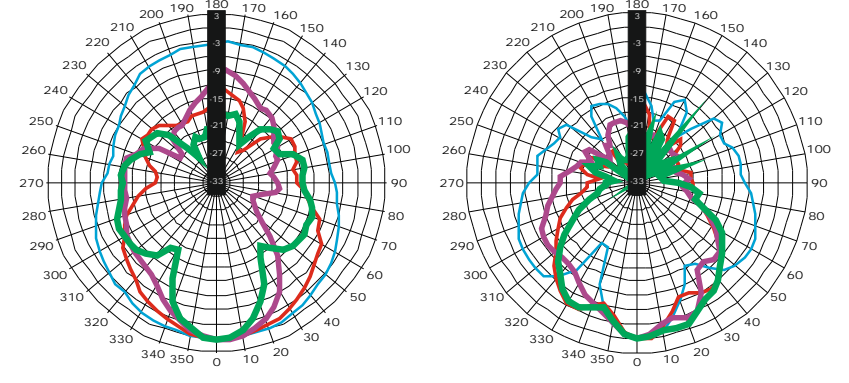

VERTICAL POLAR DIAGRAM

— 4000 — 5000 — 6300 — 8000 — 9000 — 10000 — 12500 — 14000

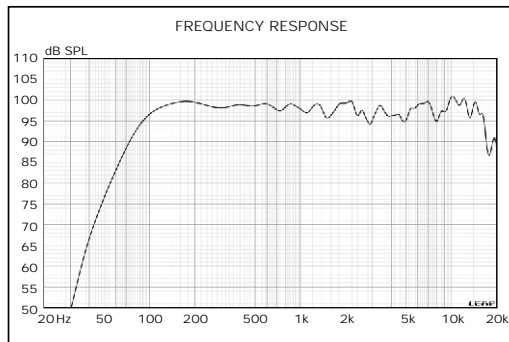
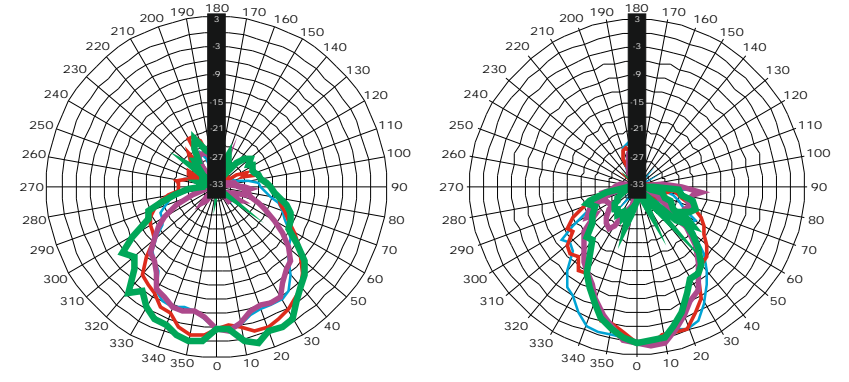



MITUS

210MA

AMPLIFIER MODULE

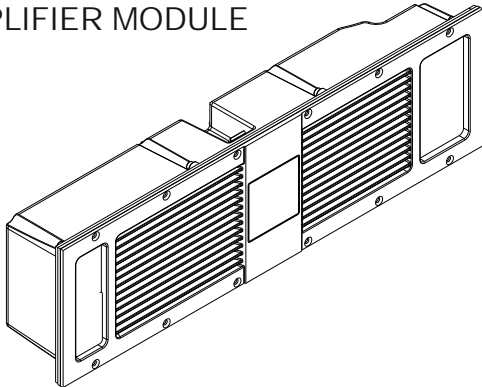

The FBT MITUS 210MA provides a high efficiency class D power amplifier module with switching power supply enclosed in a die-cast aluminium chassis.

This provides maximum protection of the electronics from dust or dirt, prevents air loss through the input control panel that can cause fastidious noise, and it maximizes heat dissipation avoiding the use of a fan to cool the circuitry.

CONNECTION PANEL

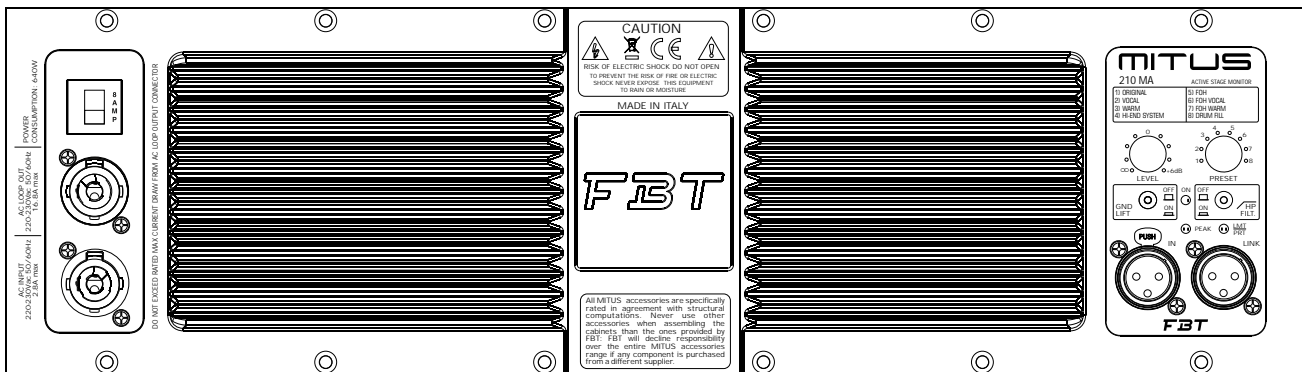

DIMENSION DRAWING

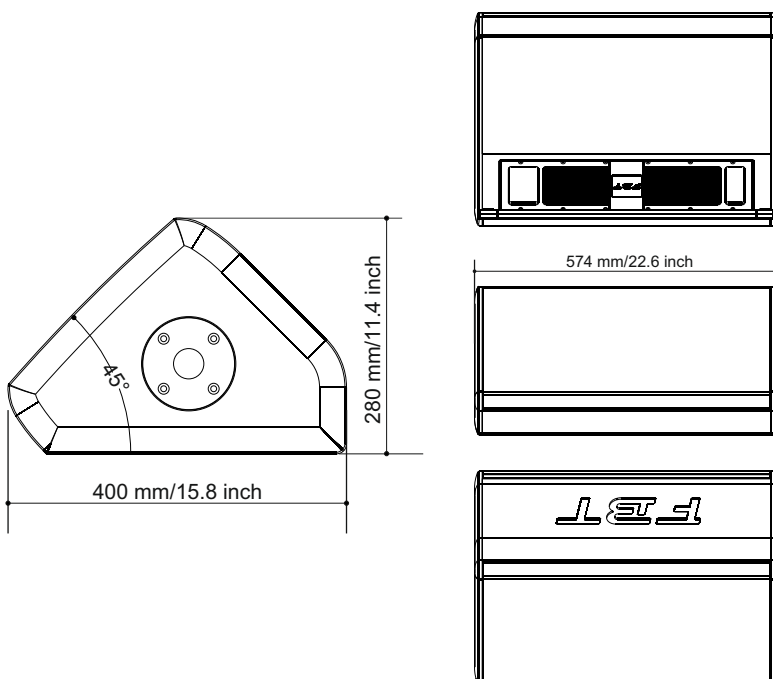

ACCESSORIES



BOX 62BK
Adjustable, for sub-satellite speaker connection with safety locking device
Ø35mm / 1.38"